

6BU8 - 3BU8 - 4BU8

TWIN PENTODE

DESCRIPTION AND RATING

The 6BU8 is a miniature multisection tube that incorporates separate plates and number-3 grids for the two sections together with a common screen, number-1 grid, and cathode. The tube is intended for use as a combined sync-AGC tube in television receivers. In this service, when used in conjunction with suitable circuitry, one section of the 6BU8 functions as sync separator and sync clipper, while the other section is used to generate the automatic-gain-control voltage. In addition, by utilizing the common number-1 grid, noise pulses can be suppressed from both synchronizing and automatic-gain-control circuits.

Except for heater ratings, the 3BU8 and 4BU8 are identical to the 6BU8. In addition, they incorporate a controlled heater warm-up characteristic which makes them especially suited for use in television receivers that employ series-connected heaters.

GENERAL

ELECTRICAL	3BU8	4BU8	6BU8
Cathode—Coated Unipotential			
Heater Voltage, AC or DC	3.15	4.2	6.3 ± 10% Volts
Heater Current	0.6 ± 6%	0.45 ± 6%	0.3 Amperes
Heater Warm-up Time*	11	11	... Seconds
Direct Interelectrode Capacitances, approximate†			
Grid-Number 3 to Plate, Each Section			1.9 μμf
Grid-Number 1 to All			6.0 μμf
Grid-Number 3 (Each Section) to All			3.6 μμf
Plate (Each Section) to All			3.0 μμf
Grid-Number 3 (Section 1) to			
Grid-Number 3 (Section 2), maximum			0.015 μμf

MECHANICAL

Mounting Position—Any
Envelope—T-6½, Glass
Base—E9-1, Small Button 9-Pin

BASING DIAGRAM

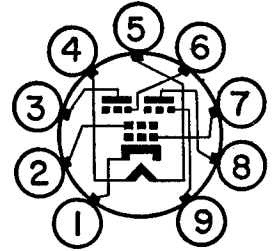

EIA 9FG

TERMINAL CONNECTIONS

- Pin 1—Cathode
- Pin 2—Grid Number 2 (Screen) and Internal Shield
- Pin 3—Plate (Section 2)
- Pin 4—Heater
- Pin 5—Heater
- Pin 6—Grid Number 3 (Section 2)
- Pin 7—Grid Number 1
- Pin 8—Plate (Section 1)
- Pin 9—Grid Number 3 (Section 1)

PHYSICAL DIMENSIONS

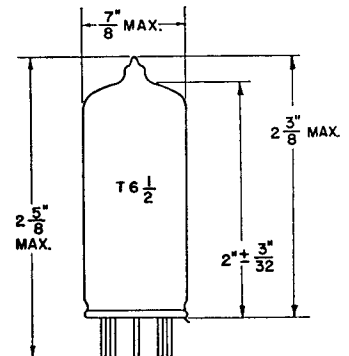

EIA 6-3

GENERAL ELECTRIC

Supersedes ET-T980, dated 12-55

MAXIMUM RATINGS

DESIGN-MAXIMUM VALUES

Plate Voltage, Each Section	300 Volts
Screen Voltage	150 Volts
Positive DC Grid-Number 3 Voltage, Each Section	3.0 Volts
Negative DC Grid-Number 3 Voltage, Each Section	50 Volts
Peak Positive Grid-Number 3 Voltage, Each Section	50 Volts
Negative DC Grid-Number 1 Voltage	50 Volts
Plate Dissipation, Each Section	1.1 Watts
Screen Dissipation	0.75 Watts
DC Cathode Current	12 Milliamperes
Heater-Cathode Voltage	
Heater Positive with Respect to Cathode	
DC Component	100 Volts
Total DC and Peak	200 Volts
Heater Negative with Respect to Cathode	
Total DC and Peak	200 Volts
Grid-Number 1 Circuit Resistance	0.5 Megohms
Grid-Number 3 Circuit Resistance, Each Section	0.5 Megohms

Design-Maximum Ratings are the limiting values expressed with respect to bogie tubes at which satisfactory tube life can be expected to occur. To obtain satisfactory circuit performance, therefore, the equipment designer must establish the circuit design so that no design-maximum value is exceeded with a bogie tube under the worst probable operating conditions with respect to supply-voltage variation, equipment component variation, equipment control adjustment, load variation, and environmental conditions.

CHARACTERISTICS AND TYPICAL OPERATION

AVERAGE CHARACTERISTICS, BOTH SECTIONS OPERATING

Plate Voltage, Each Section	100	100 Volts
Screen Voltage	67.5	67.5 Volts
Grid-Number 3 Voltage, Each Section	-10	0 Volts
Grid-Number 1 Voltage	‡	‡
Plate Current, Each Section		2.2 Milliamperes
Screen Current	6.5	3.3 Milliamperes
Cathode Current	6.6	7.8 Milliamperes

AVERAGE CHARACTERISTICS, EACH SECTION SEPARATELY WITH PLATE AND GRID-NUMBER 3 OF OPPOSITE SECTION GROUNDED

Plate Voltage	100	100 Volts
Screen Voltage	67.5	67.5 Volts
Grid-Number 3 Voltage	0	0 Volts
Grid-Number 1 Voltage	0	‡ Volts
Grid-Number 3 Transconductance		180 Micromhos
Grid-Number 1 Transconductance	1500	... Micromhos
Plate Current		2.2 Milliamperes
Grid-Number 3 Voltage, approximate		
I _b = 100 Microamperes		-4.5 Volts
Grid-Number 1 Voltage, approximate		
I _b = 100 Microamperes		-2.3 Volts

* The time required for the voltage across the heater to reach 80 percent of its rated value after applying 4 times rated heater voltage to a circuit consisting of the tube heater in series with a resistance equal to 3 times the rated heater voltage divided by the rated heater current.

† Without external shield.

‡ With grid current adjusted for 100 microamperes d-c.

AVERAGE PLATE CHARACTERISTICS

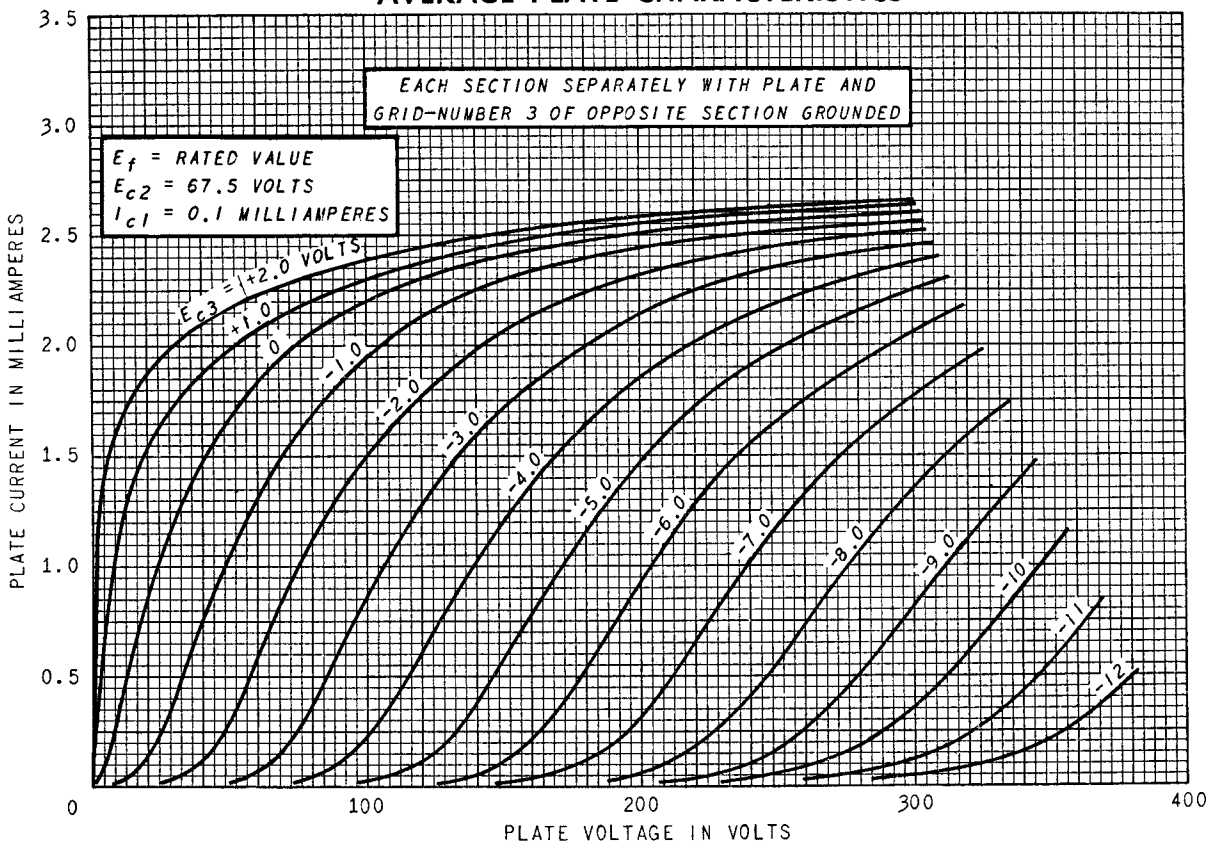

AVERAGE PLATE CHARACTERISTICS

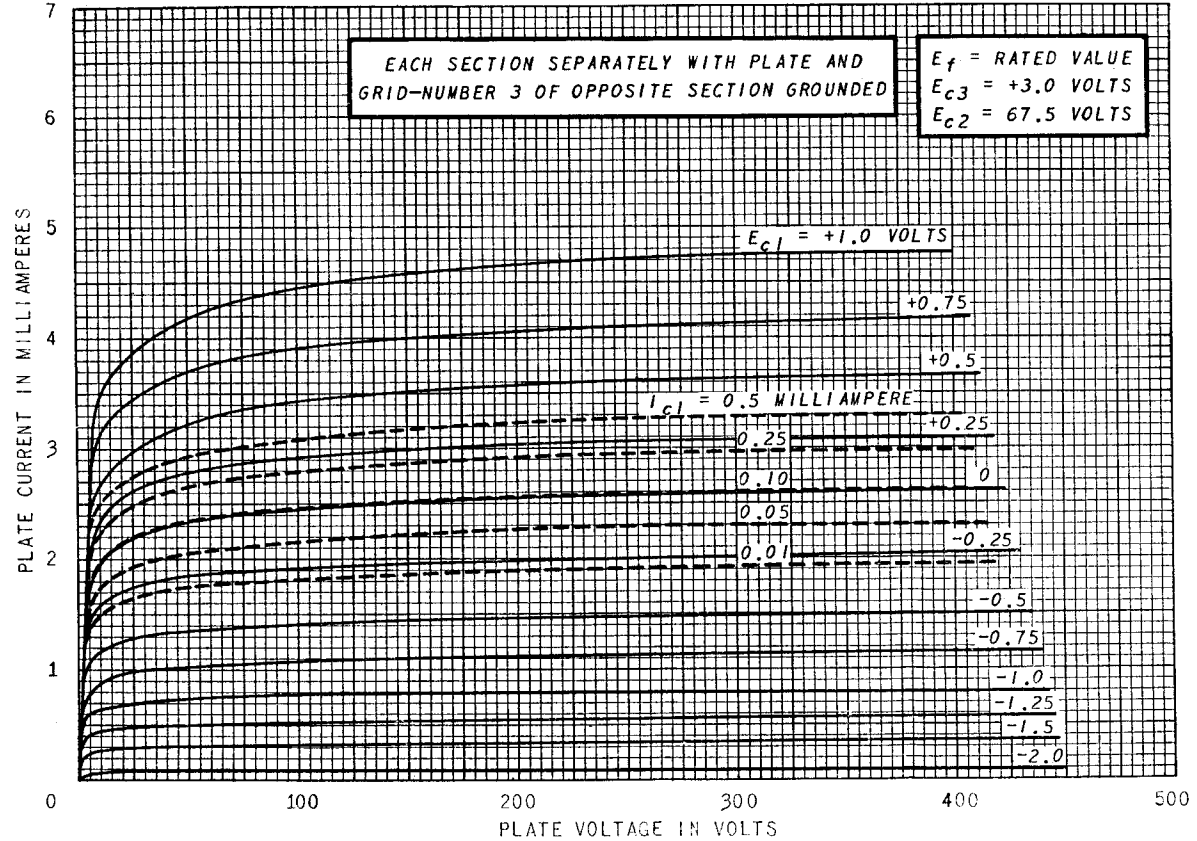

AVERAGE CHARACTERISTICS

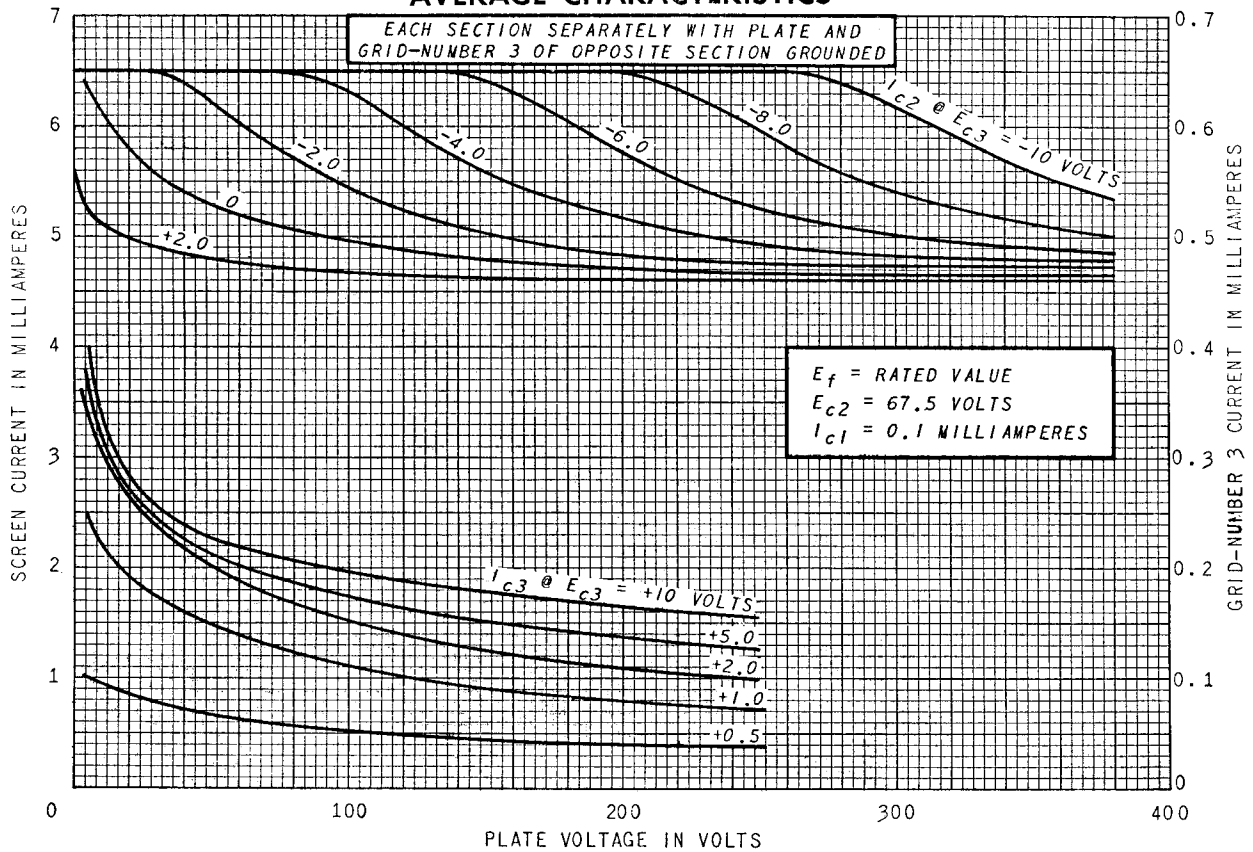

AVERAGE TRANSFER CHARACTERISTICS

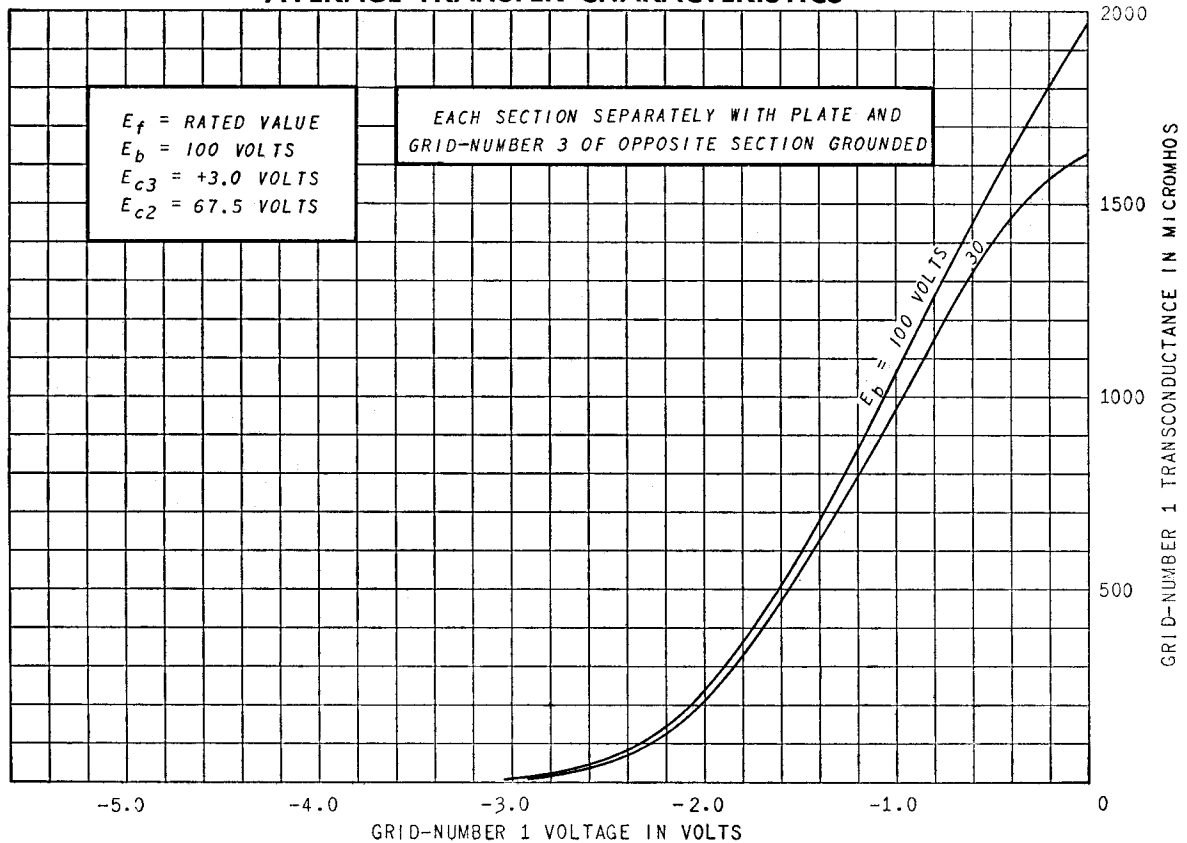

AVERAGE TRANSFER CHARACTERISTICS

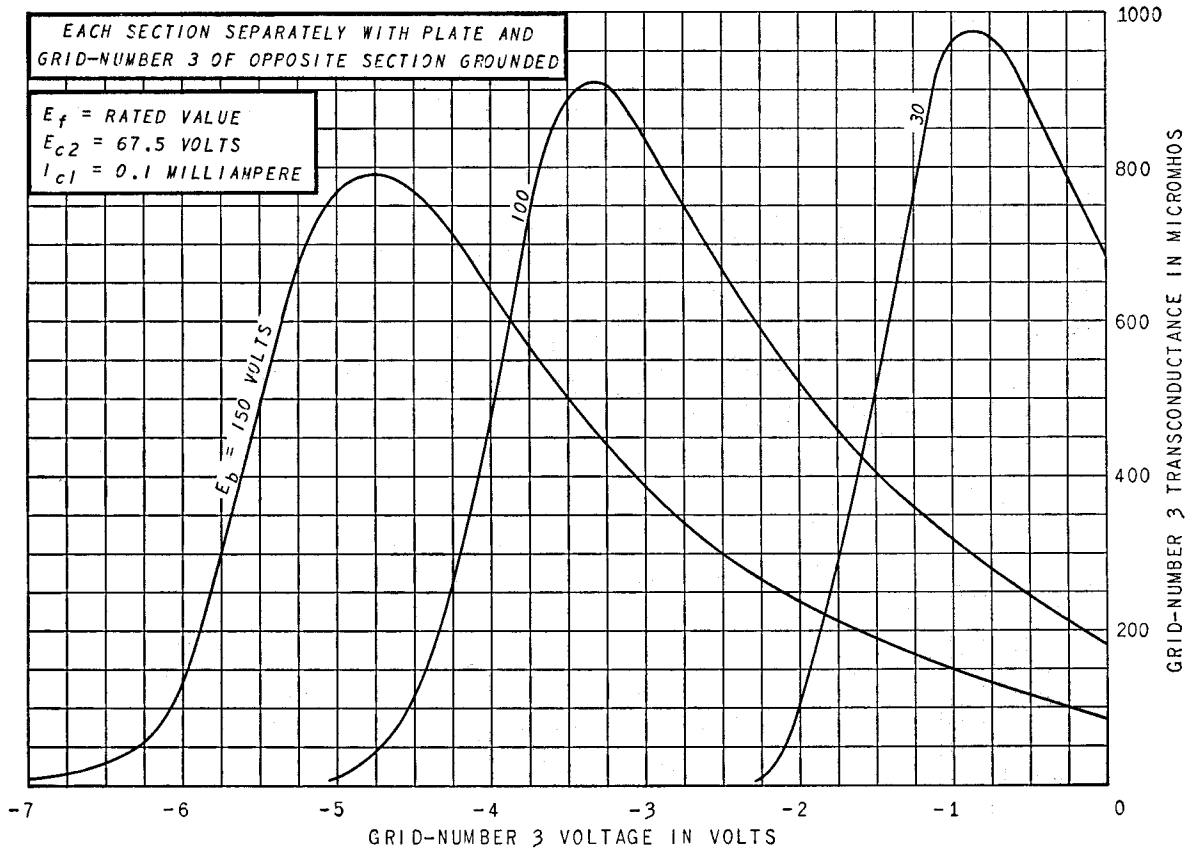

AVERAGE TRANSFER CHARACTERISTICS

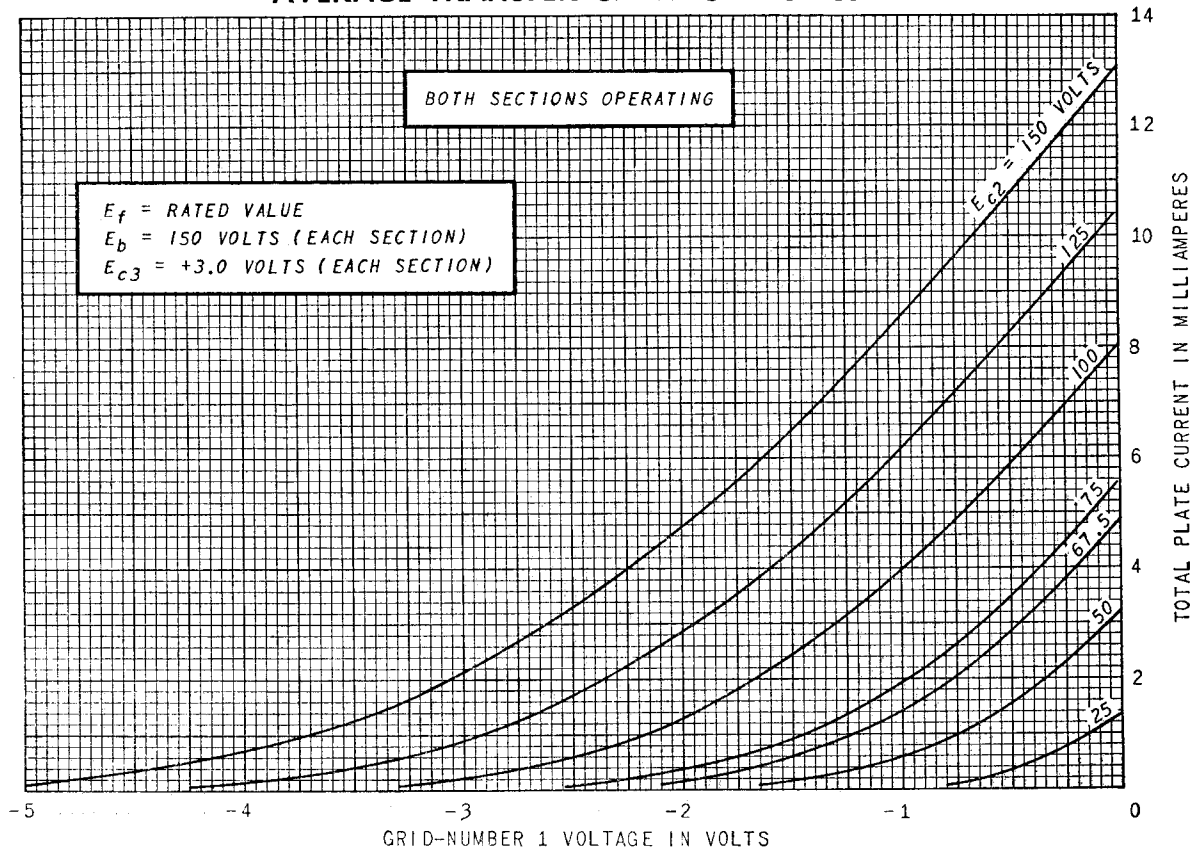

AVERAGE TRANSFER CHARACTERISTICS

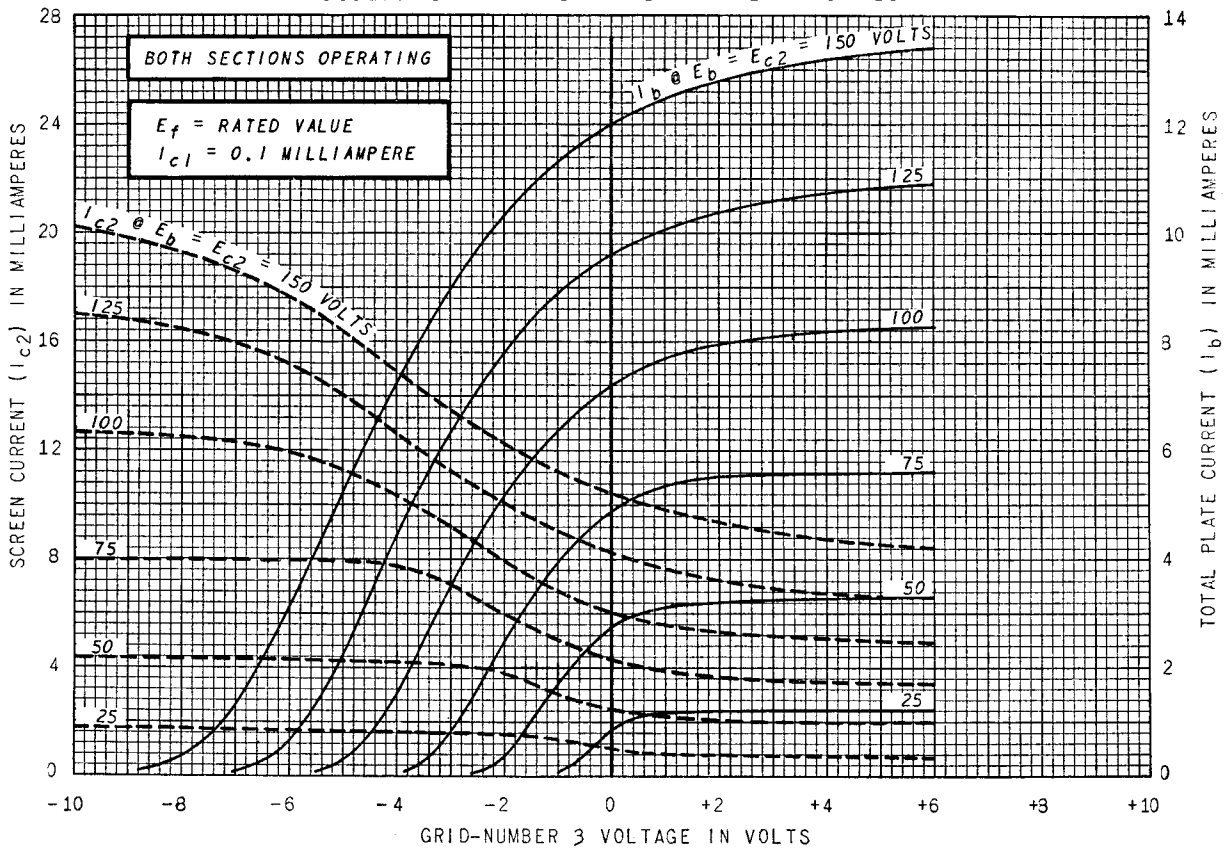

AVERAGE TRANSFER CHARACTERISTICS

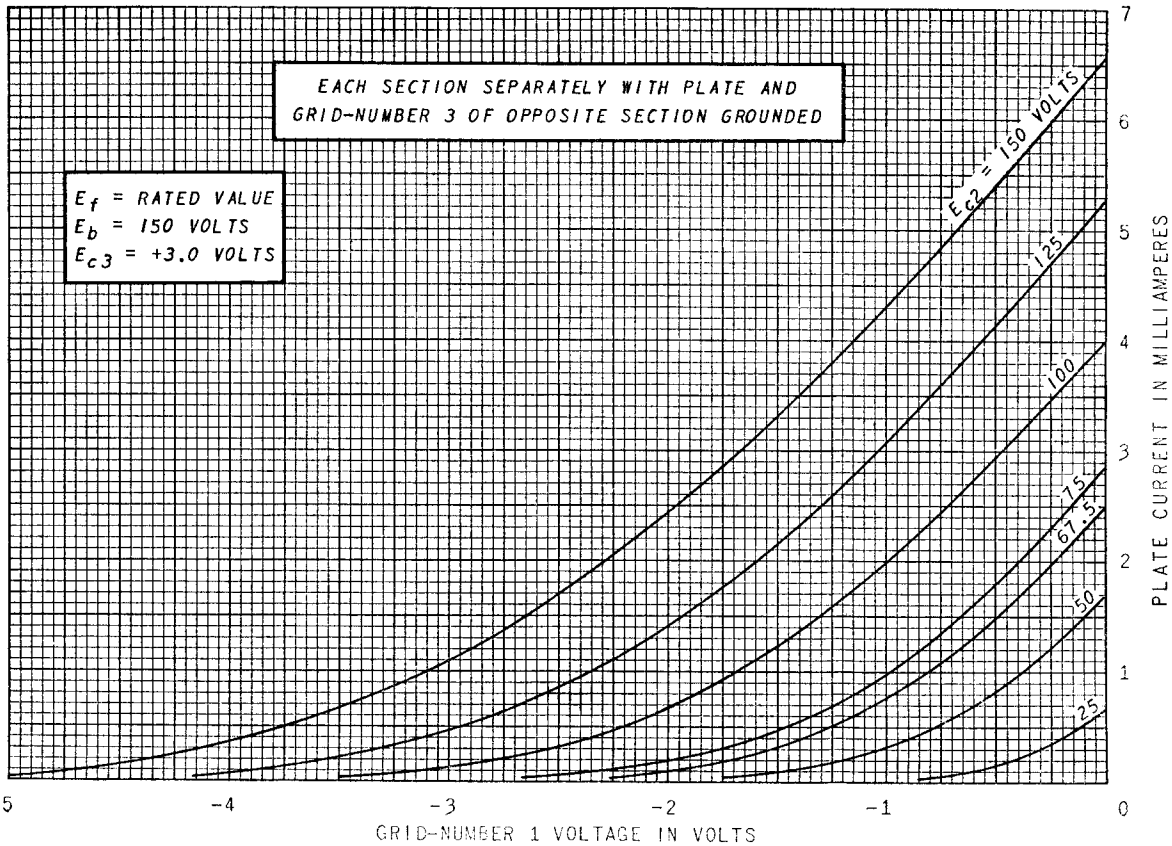

AVERAGE TRANSFER CHARACTERISTICS

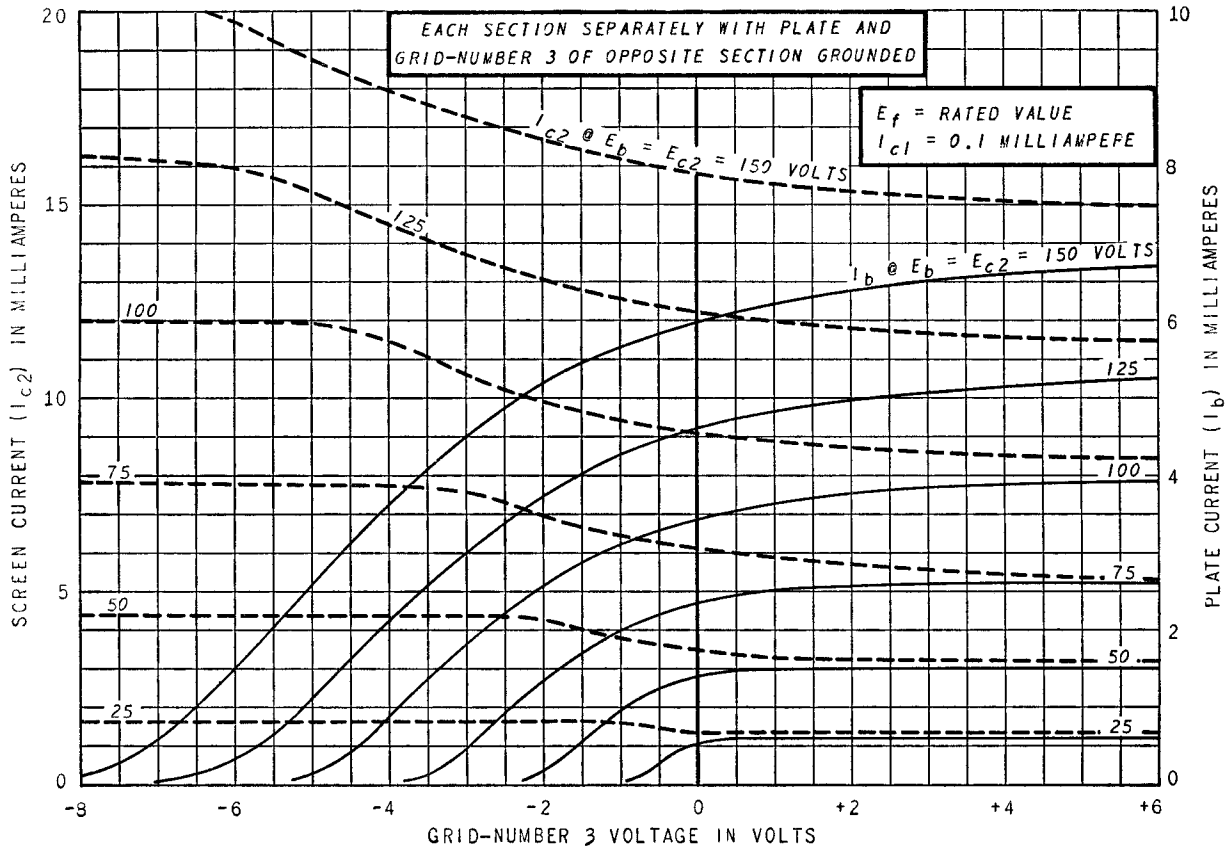

AVERAGE TRANSFER CHARACTERISTICS

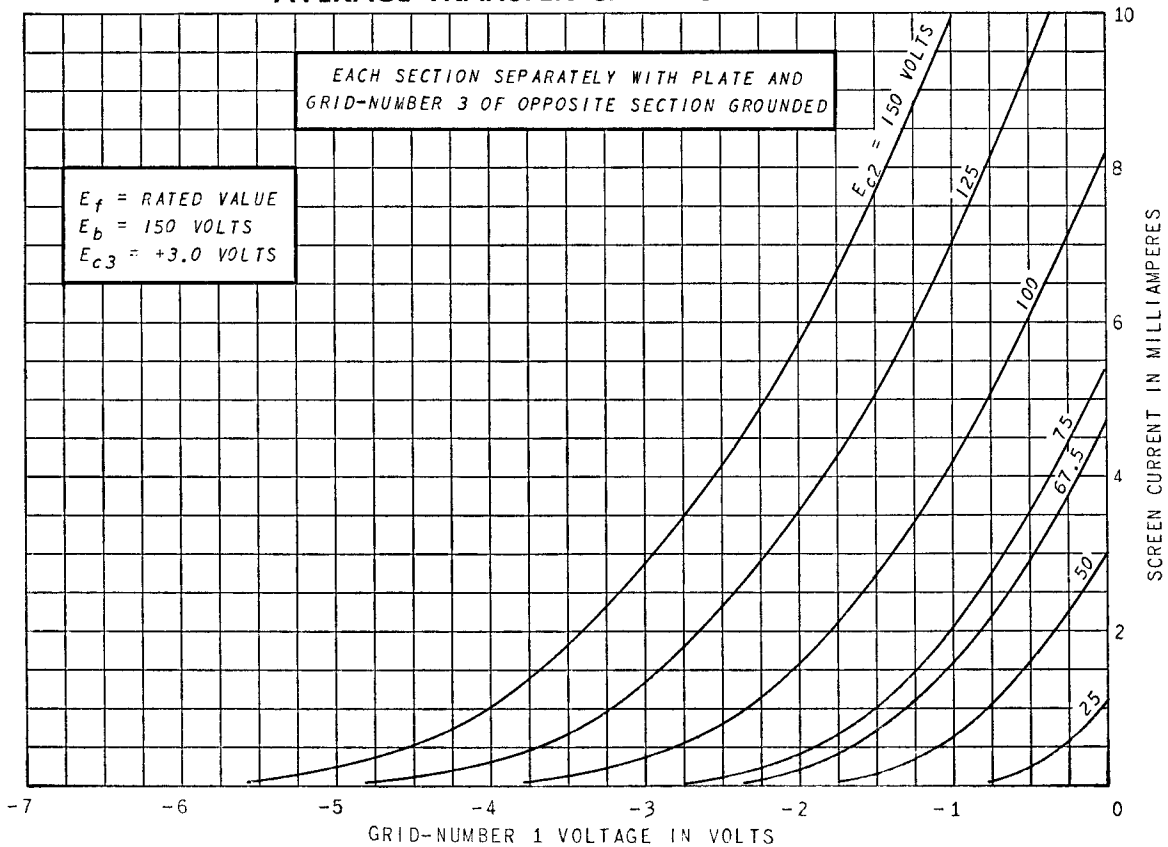

AVERAGE TRANSFER CHARACTERISTICS

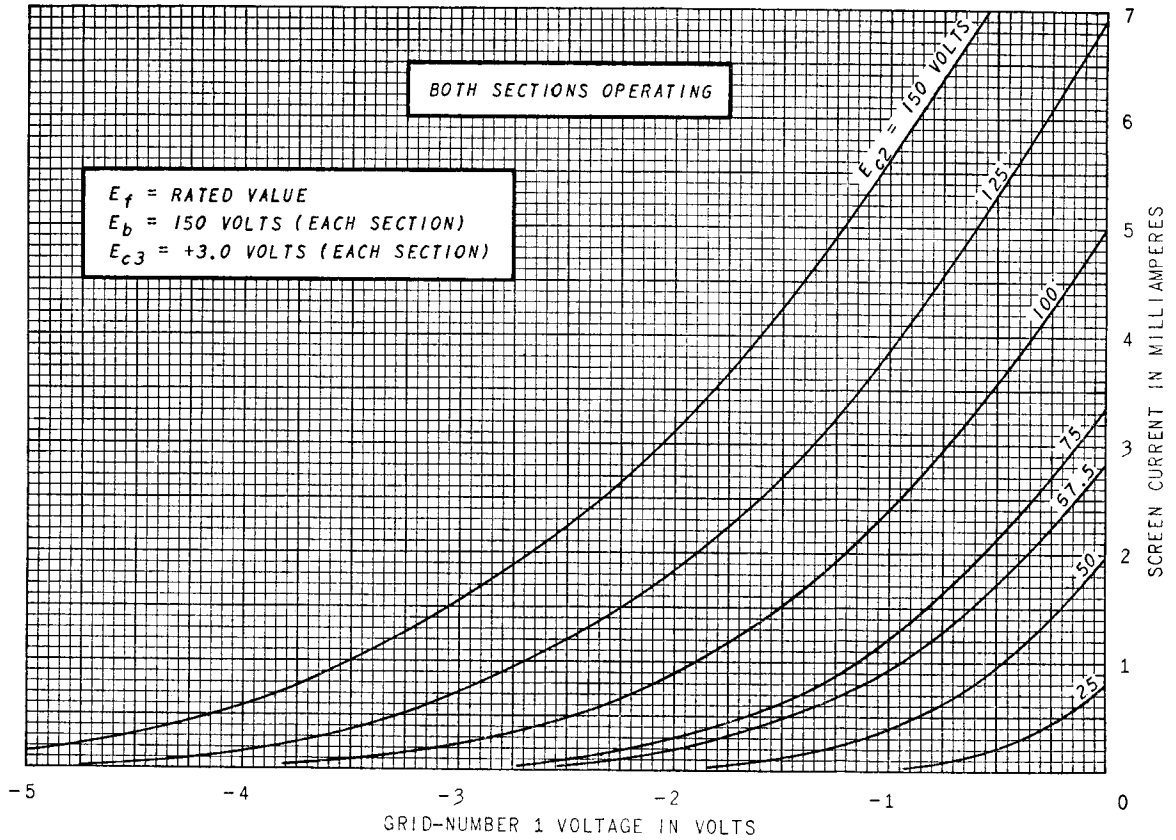

ELECTRONIC COMPONENTS DIVISION
GENERAL ELECTRIC
 Schenectady 5, N. Y.